

Panasonic

Panasonic

HC2E-H-AC48V-F

Part Number:

HC2E-H-AC48V-F

Výrobce / značka:

Panasonic

Popis produktu

HC RELAY 2 FORM C 48VAC

Datasheety:

 [HC2E-H-AC48V-F.pdf](#)

Stav RoHs

 Bez olova / V souladu RoHS

Odeslat z

Hongkong

Cesta zásilkly

DHL/Fedex/TNT/UPS/EMS

ŽÁDOST O NABÍDKU

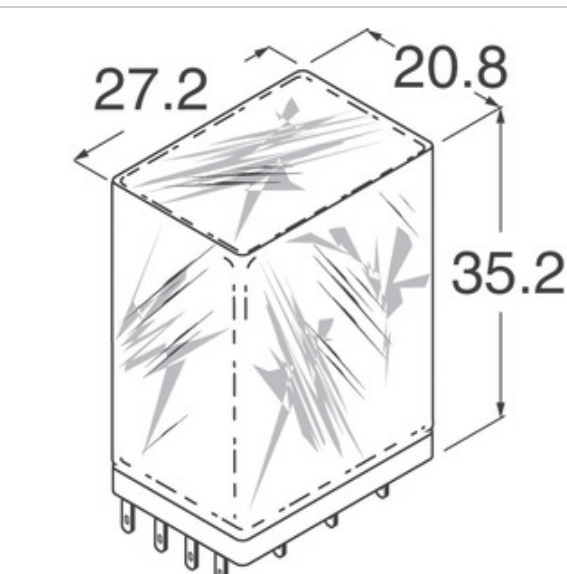

Obráz může být reprezentován. Viz specifikace podrobností o produktu.









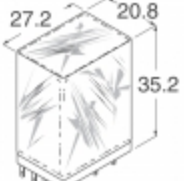

Specifikace HC2E-H-AC48V-F

PART NUMBER	HC2E-H-AC48V-F
VÝROBCE	Panasonic
POPIS	HC RELAY 2 FORM C 48VAC
STAV VOLNÉHO VEDENÍ / ROHS	Bez olova / V souladu RoHS
DATOVÝ LIST	 HC2E-H-AC48V-F.pdf
SÉRIE	*
ÚROVEŇ CITLIVOSTI NA VLHKOST (MSL)	1 (Unlimited)
STAV VOLNÉHO VEDENÍ / ROHS	Lead free / RoHS Compliant
DETAILNÍ POPIS	Relay Coil

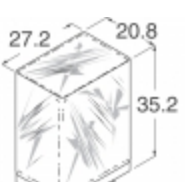
Související značky

Panasonic HC2E-H-AC48V-F	HC2E-H-AC48V-F Distributor	Dodavatel HC2E-H-AC48V-F
Cena HC2E-H-AC48V-F	Obrázky HC2E-H-AC48V-F	Obrázek HC2E-H-AC48V-F
HC2E-H-AC48V-F Datasheet PDF	HC2E-H-AC48V-F Datasheet ke stažení	HC2E-H-AC48V-F Datasheet
HC2E-H-AC48V-F Stock	Koupit HC2E-H-AC48V-F	Koupit Panasonic HC2E-H-AC48V-F
Panasonic HC2E-H-AC48V-F	Dodavatel Panasonic	Panasonic Distributor
Panasonic HC2E-H-AC48V-F	Panasonic - Consumer Division HC2E-H-AC48V-F	Panasonic - Consumer Electronics Corp. HC2E-H-AC48V-F
Panasonic Battery Group HC2E-H-AC48V-F	Panasonic Electric Works - ACSO HC2E-H-AC48V-F	Panasonic Electronic Components - Semiconductor Pr HC2E-H-AC48V-F
Panasonic - ATG HC2E-H-AC48V-F	Panasonic - BSG HC2E-H-AC48V-F	Panasonic - DTG HC2E-H-AC48V-F
Panasonic Electric Works HC2E-H-AC48V-F	Panasonic Electronic Components HC2E-H-AC48V-F	Panasonic Industrial Automation Sales HC2E-H-AC48V-F
Panasonic Semiconductor HC2E-H-AC48V-F		

Související produkty

 <p>HC2E-H-AC6V-F Výrobci: Panasonic Popis: HC RELAY 2 FORM C 6VAC Na skladě: Out stock RFQ</p>	 <p>HC2E-H-DC110V-F Výrobci: Panasonic Popis: HC RELAY Na skladě: Out stock RFQ</p>
 <p>HC2E-H-AC6V Výrobci: Panasonic Popis: RELAY GENERAL PURPOSE DPDT 3A 6V Na skladě: Out stock RFQ</p>	 <p>HC2E-H-AC24V Výrobci: Panasonic Popis: RELAY GEN PURPOSE DPDT 3A 24V Na skladě: Out stock RFQ</p>
 <p>HC2E-H-AC200V-F Výrobci: Panasonic Popis: RELAY GEN PURP DPDT 200VAC Na skladě: Out stock RFQ</p>	 <p>HC2E-H-AC24V-F Výrobci: Panasonic Popis: HC RELAY 2 FORM C 24VAC Na skladě: Out stock RFQ</p>
 <p>HC2E-H-DC100V-F Výrobci: Panasonic Popis: RELAY GEN PURP DPDT 100VDC Na skladě: Out stock RFQ</p>	 <p>HC2E-H-DC12V Výrobci: Panasonic Popis: RELAY GEN PURPOSE DPDT 3A 12V Na skladě: Out stock RFQ</p>
 <p>HC2E-H-DC110V Výrobci: Panasonic Popis: RELAY GEN PURPOSE DPDT 3A 110V Na skladě: Out stock RFQ</p>	 <p>HC2E-H-AC240V-F Výrobci: Panasonic Popis: HC RELAY 2 FORM C 240VAC Na skladě: Out stock RFQ</p>
 <p>HC2E-H-AC240V Výrobci: Panasonic Popis: RELAY GEN PURPOSE DPDT 3A 240V Na skladě: Out stock RFQ</p>	 <p>HC2E-H-AC48V Výrobci: Panasonic Popis: RELAY GEN PURPOSE DPDT 3A 48V Na skladě: Out stock RFQ</p>