

## Introduction

The ISL6745EVAL2Z utilizes Intersil's double-ended voltage mode PWM controller for a SEPIC converter application requiring a constant output current. It consists of separate assemblies for the driver and for the LED board, which supports as many as 21 high brightness LEDs. The LED driver board converts a universal (85V to 275VAC) AC input to a DC output rated at 300mA. The design can be further optimized for applications that do not require universal AC input. ISL6745LEVAL2Z is for 80V to 140V applications.

Worldwide, on average, 19% of the electric power goes for lighting [11]. In 2000, about 567BKWH of electric energy (or 16% of the nation's electric energy in the United States) is for residential, commercial or industrial lighting [22], [3]33. The commonly used lighting technologies include incandescent and halogen bulbs, fluorescent and compact fluorescent lamps (CFL), and high intensity discharge (HID) lamps. Generally, the efficiency of the lighting sources is indexed by efficacy, or lumen per watt weighted to the sensitivity of the human eye. The efficacy of typical energy saving CFL lamps is around 7%~8%, compared with 2% for the conventional the incandescent bulbs [4]. With the advancement of new materials and manufacturing processes, the economics and performance of high brightness LEDs are now attracting the attention of academia and industry. For instance, in 2006, Cree Inc. demonstrated a prototype with a record white LED luminous efficacy of 131 lm/W [5]. Compared with commonly used lighting sources, white LEDs provide equivalent or superior efficacy, and improvements are announced frequently. Unlike the CFLs, LEDs contains no mercury, and are less susceptible to breakage. They have a very long expected life (100,000 hours, more than 10x as much as CFLs), and high on/off repetition capability. Of particular interest, they are easy to power when compared to many traditional sources. The practical application of LED lighting for commercial and residential applications has become a reality. The typical operating current of the high brightness LED is about 300mA~1000mA. The typical drive voltage for high brightness white LED is about 2.5V to 4V.

The ISL6745EVAL2Z evaluation board is a reference design for powering high brightness white LEDs. It utilizes the ISL6745 voltage mode PWM controller in the single-ended primary inductance converter (SEPIC) topology to convert a universal ac input to a variable 300mA DC output. See Figure 1.

This application note describes the circuit operation design constraints, description of the evaluation board, and its performance.

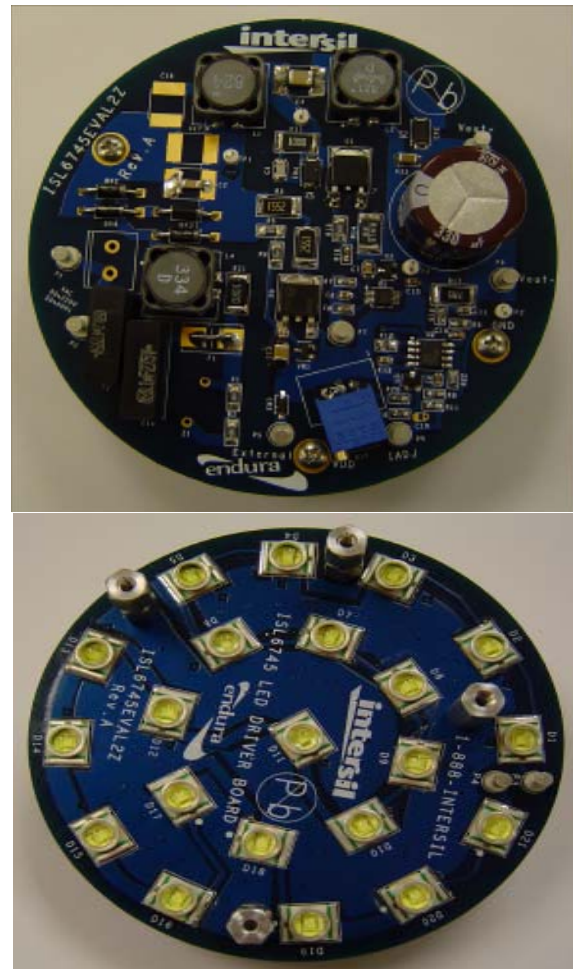

FIGURE 1. TOP VIEW OF DRIVE AND LED BOARDS

## Key Features

- Universal AC Input
- Dimmable LED Brightness
- High Power Factor
- Overvoltage Protection
- Overcurrent Protection
- Transformerless

## Specifications for ISL6745EVAL2Z

- Input AC Voltage . . . . . 85V to 275VAC (50Hz~60Hz)
- Outputs DC . . . . . Up to 300mA
- Output DC Voltage Ripple . . . . . 5%
- Typical Efficiency . . . . . 75%
- Typical Power Factor . . . . . >0.95

**Operation Mechanism and Design Constraints**

A simplified offline SEPIC converter for LED lighting applications is shown in Figure 3, where the voltage across  $C_1$  is the rectified AC voltage. A current sense resistor is placed in series with the switch  $S_1$ . A second resistor is placed in series with the LED string to sense the load current. The control signals include the load current and switch current. The output voltage is sensed for the purpose of output overvoltage protection (OVP). Since the input capacitor  $C_1$  is very small, the voltage waveform is the rectified input voltage, and the voltage applied to the SEPIC converter is approximately a rectified sinusoidal. To achieve high power factor, the envelope of the converter input current must track the rectified input voltage waveform. This is accomplished when the converter is operated at a constant switching frequency, a constant duty ratio, and while operating in the discontinuous conduction mode (DCM). Assuming the impedance of the power source is negligible, the voltage across  $C_1$  is given in Equation 1, where subscript I denotes input AC line, and  $V_I$  is the amplitude of the input AC voltage with frequency  $\omega_I$ .

$$v_{C1}(t) = V_I |\sin(\omega_I t)| \quad (\text{EQ. 1})$$

If the switching frequency of the converter is much higher than the utility frequency, and  $C_2$  is properly sized, the voltage across  $C_2$  will be equal to the voltage across  $C_1$ . A feedback voltage,  $V_m$ , is created by the error amplifier.  $V_m$  is the amplified difference between the LED current,  $I_o$ , and the reference voltage,  $I_r$ . Varying the reference voltage causes a proportional change in the LED brightness. The current signal from the current sense resistor,  $R_{cs}$ , which is connected in series with the boost switch  $S_1$ , is compared with the overcurrent threshold for overcurrent protection. A sawtooth carrier signal is compared with the feedback signal  $V_m$  and generates the PWM signal to control the turn on/off of the switch. Typical waveforms of the inductor current, switch and diode currents are shown in Figure 2.

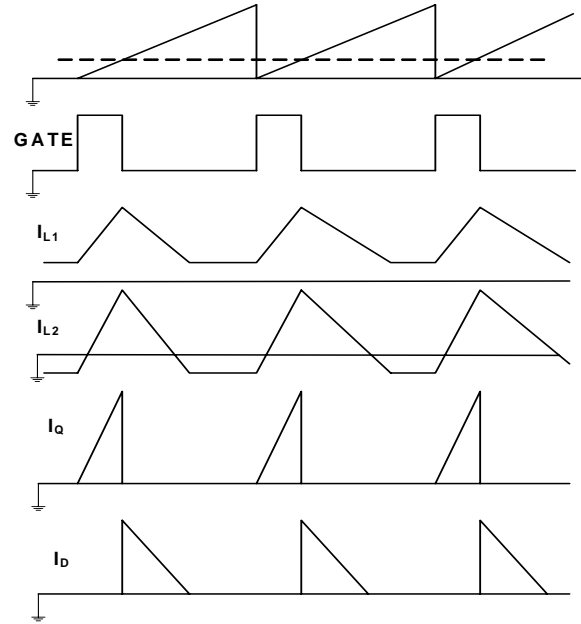

FIGURE 2. TYPICAL OPERATION WAVEFORMS

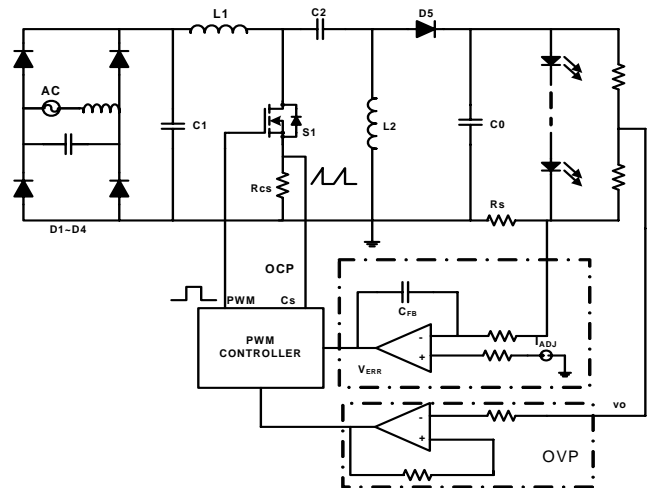

FIGURE 3. SEPIC CONVERTER FOR LED LIGHTING

TABLE 1. SEPIC CONVERTER

NAME	DESCRIPTION
AC	85V ~ 265VAC, 50Hz ~ 60Hz
D1 ~ D4	Bridge Rectifier
$C_1$	Input Capacitor
$L_1/L_2$	SEPIC Inductors
$S_1$	High Voltage MOSFET
$C_0$	Output Capacitor
$C_2$	Intermediate Capacitor
$R_S$	Current Sense Resistor
PWM	ISL6745A PWM Controller

TABLE 1. SEPIC CONVERTER (Continued)

NAME	DESCRIPTION
C <sub>F</sub>	Feedback Capacitor
I <sub>ADJ</sub>	Brightness Dimming Control
CS	The MOSFET Current
D <sub>5</sub>	Output Diode

There are three stages of operations:

1. The switch turns on, Diode is off.
2. The switch turns off, the diode is on.
3. Both switch and diode are off.

During each switching period, the following circuit equations can be derived.

### SWITCH S1 TURNS ON

At the beginning of the cycle, when switch S1 turns on, the free-wheeling current in L<sub>1</sub> is i<sub>L1</sub>(0) and the voltage across the input inductor L<sub>1</sub> is V<sub>C1</sub>. The freewheeling current in L<sub>1</sub> is i<sub>L1</sub>(0). The voltage applied to the input inductor L<sub>1</sub> is V<sub>C1</sub>. Since the voltage across C<sub>2</sub> equals V<sub>C1</sub>, the same voltage is applied to L<sub>2</sub>. The inductor currents are given in Equation 2, where 0 denote the initial condition of the state variables. The switch current is the sum of the two inductor currents, and is given in Equation 3. This stage ends at t<sub>ON</sub>.

$$i_{L1}(t) = i_{L1(0)} + \frac{V_{C1}}{L_1}t \quad (\text{EQ. 2})$$

$$i_{L2}(t) = -i_{L1(0)} + \frac{V_{C1}}{L_2}t$$

$$i_Q(t) = i_{L1}(t) + i_{L2}(t) = \left( \frac{V_{C1}}{L_1} + \frac{V_{C1}}{L_2} \right)t \quad (\text{EQ. 3})$$

### DIODE D5 CONDUCTS

The voltage applied to inductor L<sub>1</sub> is -V<sub>O</sub>, the same as inductor L<sub>2</sub>. The current in L<sub>1</sub> decays according to Equation 4. The current in L<sub>2</sub> decays and reverses. This stage ends when i<sub>L1</sub> equals -i<sub>L2</sub>. The diode current is the sum of both the inductor currents. The currents are given in Equation 5, where t<sub>ON</sub> is the interval when the switch is on.

$$i_{L1}(t) = \left( i_{L1(0)} + \frac{V_{C1}}{L_1}t_{ON} - \left( \frac{V_O}{L_1} \right)t \right) \quad (\text{EQ. 4})$$

$$i_{L2}(t) = \left( i_{L1(0)} + \frac{V_{C1}}{L_1}t_{ON} - \frac{V_O}{L_1}t \right)$$

$$i_D(t) = (V_{C1}t_{ON} - V_O t) \left( \frac{1}{L_1} + \frac{1}{L_2} \right) \quad (\text{EQ. 5})$$

### DIODE D5 AND SWITCH S1 BLOCKING

This is the freewheeling period of both inductors L<sub>1</sub> and L<sub>2</sub>. The freewheeling currents are given in Equation 6.

$$i_{L1}(1) = \left( i_{L1(0)} + \frac{V_{C1}}{L_1}t_{ON} - \frac{V_O}{L_1}t_d \right) \quad (\text{EQ. 6})$$

$$i_{L2}(1) = \left( i_{L1(0)} + \frac{V_{C1}}{L_2}t_{ON} - \frac{V_O}{L_1}t_d \right)$$

where, the diode conducting time, t<sub>d</sub>, is determined by the volt-second balance of the inductors, where V<sub>l</sub> is the amplitude of the AC line voltage.

$$t_d = \frac{t_{ON}V_l}{V_O} |\sin \omega_1 t| \quad (\text{EQ. 7})$$

To ensure the converter operates in DCM, the freewheeling time should be greater than or equal to zero as expressed in Equation 8.

$$t_s \geq t_{ON} + t_d \quad (\text{EQ. 8})$$

Therefore, the duty ratio of the PWM is expressed in Equation 9.

$$d < \frac{V_O}{V_O + V_l} \quad (\text{EQ. 9})$$

Averaging this diode current in one switching cycle gives the average output current I<sub>O</sub>(t) during that switching cycle.

$$i_O(t) = \frac{1}{t_s} \int_0^{t_s} i_D(t) dt = \frac{1}{L_1 \parallel L_2} \frac{(t_{ON} V_l \sin(\omega_1 t))^2}{2 t_s V_O} \quad (\text{EQ. 10})$$

Averaging the I<sub>O</sub>(t) over one line period, yields the average current of the output, since the average output capacitor current is zero. Therefore, the output current equals the average diode current. The output current also equals the average current in inductor L<sub>2</sub>, since the average current in C<sub>2</sub> is zero. Therefore, the dominate ripple frequency is twice the line frequency as expressed in Equation 11.

$$i_O = \frac{1}{t_1} \int_0^{t_1} I_O(t) dt = \frac{1}{L_1 \parallel L_2} \frac{d^2 t_s V_l^2}{4 V_O} \quad (\text{EQ. 11})$$

The constraints for selecting the inductors are expressed in Equation 12:

$$L_1 \parallel L_2 < \left( \frac{V_l}{V_O + V_l} \right)^2 \frac{t_s V_O}{4 I_O} \quad (\text{EQ. 12})$$

As can be seen, the maximum ripple current in the input inductor L<sub>1</sub> occurs at the peaks of the input voltages as expressed in Equation 13.

$$I_{1rp} = \frac{t_{ON} V_l}{L_1} \quad (\text{EQ. 13})$$

Since, we assume unity power factor, and assume the power conversion efficiency is η as shown in Equation 14.

$$\frac{1}{2} V_l I_{1p} \eta = V_O I_O \quad (\text{EQ. 14})$$

If we define the ripple factor  $K_{rpi} = I_{rp}/I_1$ , where  $I_1$  is the peak of the input current, then the constraint for DCM operation of the converter is as expressed in Equation 15.

$$L_1 > \frac{t_{ON} V_1}{I_{rp}} = \frac{t_{ON} V_1}{K_{rpi} I_1} = \frac{t_{ON} (V_1)^2 \eta}{2 K_{rpi} V_{O} I_O} \quad (\text{EQ. 15})$$

$$L_2 < \left( \left[ \frac{V_1 + V_O}{V_1} \right]^2 \frac{4 I_O}{t_s V_O} - \frac{2 K_{rpi} V_O I_O}{t_{ON} V_1^2 \eta} \right)^{-1}$$

In the above analysis, it is assumed that the voltage across the input capacitor  $C_1$  is independent of the circuit operation and follows the rectified input voltage closely. Furthermore, the voltage across  $C_2$  is identical to the voltage across  $C_1$ . If the assumption is not correct, the current waveform will be distorted.

The input capacitor can be estimated by using Equation 16.

$$C_1 = \frac{4 K_{rpi}^2 t_s d p}{K_{rpi} V_1^2 L_2} \quad (\text{EQ. 16})$$

The AC source delivers power as a sine wave. Since the input is rectified, power is delivered to the load at twice the input line frequency. Therefore, the ripple frequency on the output voltage is also twice of the line frequency. To reduce the ripple, the output capacitor needs to be selected according to Equation 17.

$$C_O > \frac{V_1 I_1}{2 V_{rp-p} V_O \omega_1} \quad (\text{EQ. 17})$$

The duty ratio is controlled by the difference between the reference signal  $I_{ADJ}$  and the voltage across the current

## Waveforms

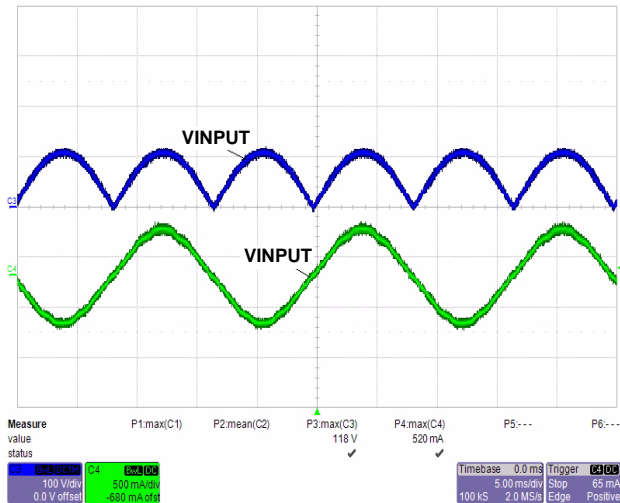

**FIGURE 4. INPUT VOLTAGE AND CURRENT (VAC = 80V,  $I_O = 30\text{mA}$ )**

sense resistor  $R_S$ . By changing the current sense resistor, or the reference signal  $I_{ADJ}$ , the brightness of the LED can be dimmed. A Type I Error Amplifier is used as shown in Figure 3, with the crossover frequency determined by the feedback capacitor  $C_{fb}$  and the resistor R, given in Equation 18.

$$\omega_C = \frac{1}{RC_{f_0}} \quad (\text{EQ. 18})$$

The bandwidth should be less than the line frequency, so that the duty ratio of the converter does not disturb the sinusoidal power delivery from the source. Otherwise, harmonics appear in the input line current and degrade power factor. However, the bandwidth should be wide enough to allow adequate control of the load current. As a trade-off, the cut-off frequency can be around half of the line frequency.

Overvoltage protection is needed to protect the LED and converter from damage. Due to the nonlinear relationship between the diode current and voltage, a small increase in output voltage can cause a large increase in current. The overvoltage protection is implemented by comparing the output voltage with a constant reference voltage, and the comparator output is used to control a small FET in parallel with the soft-start capacitor. Once the output voltage reaches the threshold, the FET is turned on, the soft-start capacitor discharged, and the duty cycle is reduced to zero. The PWM output is shutdown until the output voltage decays below the reset threshold. A new soft-start cycle begins at this time. This behavior repeats until the cause of the overvoltage is removed.

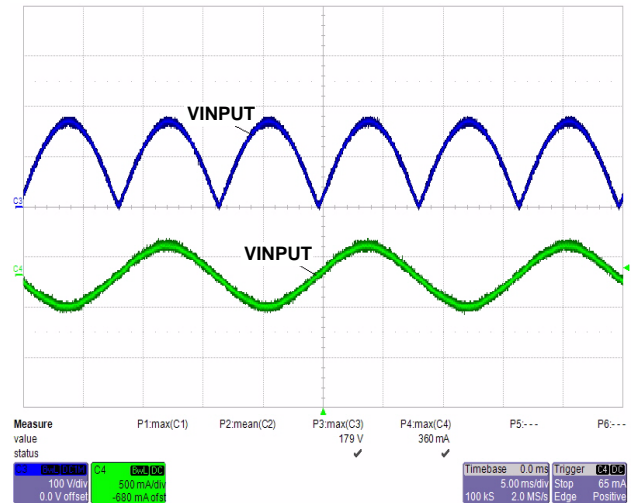

**FIGURE 5. INPUT VOLTAGE AND CURRENT, VAC = 120V,  $I_O = 300\text{mA}$**

Waveforms (Continued)

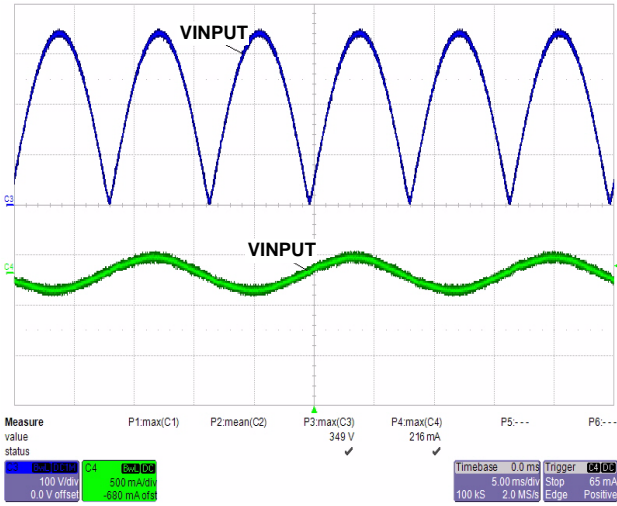

FIGURE 6. INPUT VOLTAGE AND CURRENT,  $V_{AC} = 240V$ ,  $I_O = 300mA$

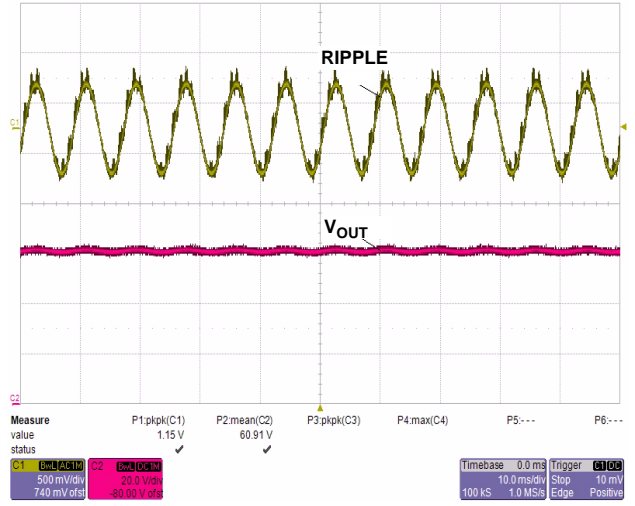

FIGURE 7. OUTPUT VOLTAGE AND RIPPLE  $I_O = 100mA$

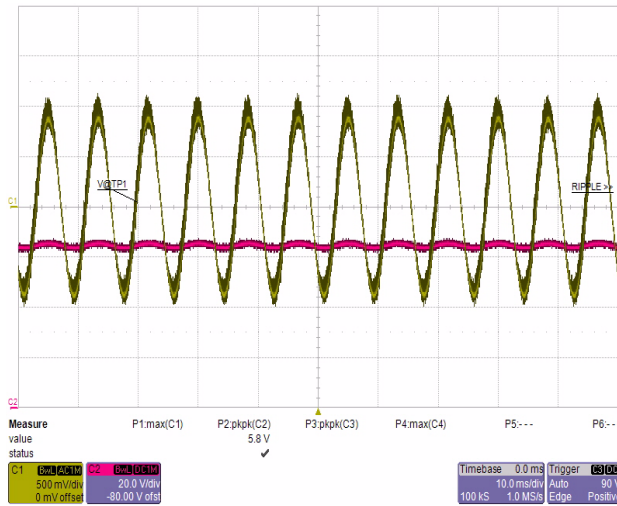

FIGURE 8. OUTPUT VOLTAGE AND RIPPLE  $I_O = 300mA$

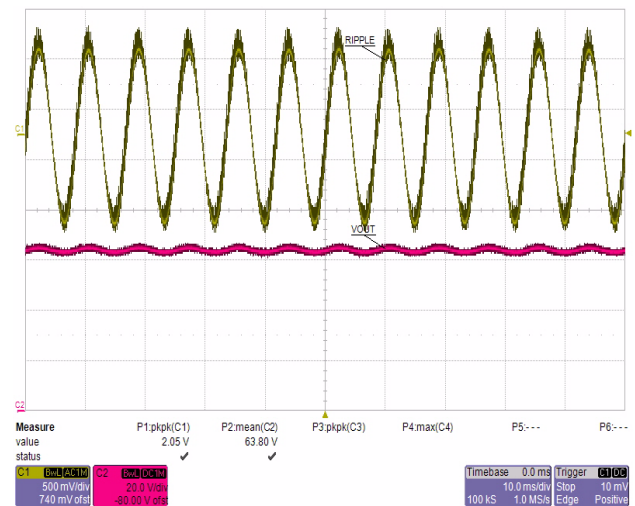

FIGURE 9. OUTPUT VOLTAGE AND RIPPLE  $I_O = 200mA$

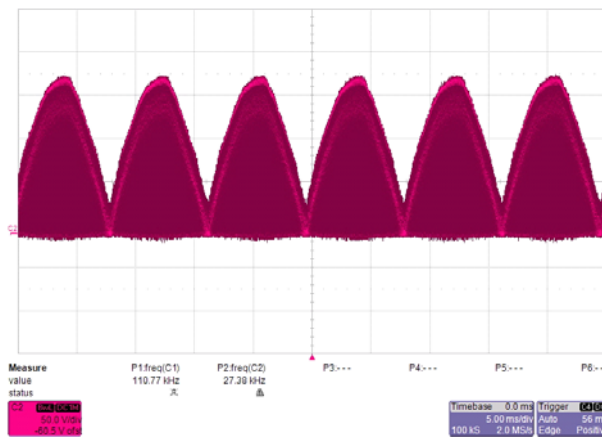

FIGURE 10. THE DRAIN-SOURCE VOLTAGE

Waveforms (Continued)

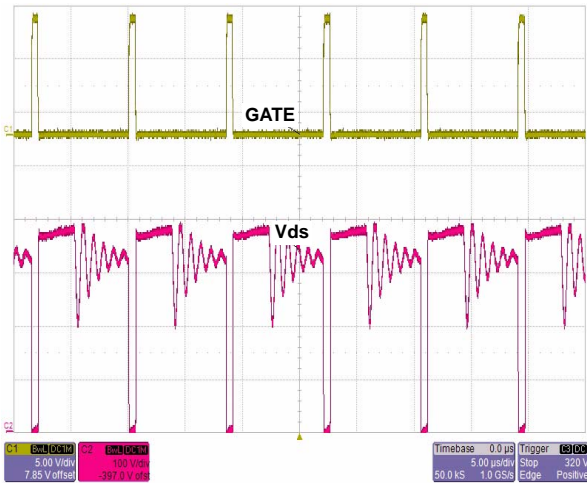

FIGURE 11A. AROUND INPUT PEAK

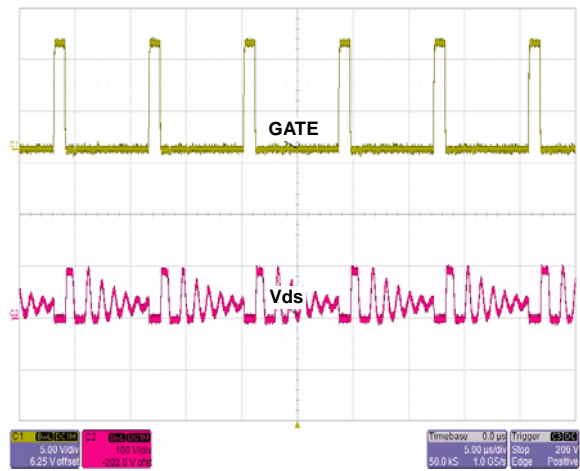

FIGURE 11B. AROUND INPUT VALLEY

FIGURE 11. THE GATE SIGNAL AND DRAIN-SOURCE VOLTAGES

Performance of ISL6745UEVAL2Z

The schematic of the ISL6745UEVAL2Z evaluation board is shown in page 12. The bill of material (BOM) for universal AC application is shown on page 8. Figure 1 on page 1 shows photographs of the drive board and LED board. The configuration of the test bench is shown in Figure 12.

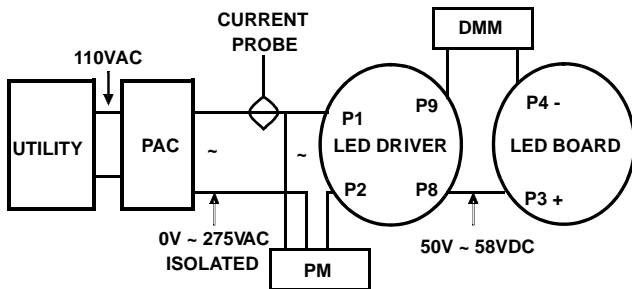

FIGURE 12. TEST BENCH CONFIGURATION

TABLE 2. TEST BENCH CONFIGURATION TEST

PM	DMM	PAC
Power Meter	Digital Multimeter	Programmable AC Power Supply

To perform the bench testing, the following equipment is necessary:

- Programmable AC power supply, 275VAC minimum
- Fan to cool heatsinks
- Oscilloscope, 4 channels, 20MHz minimum bandwidth
- DC electronic load, 1A minimum
- DC Multimeter
- Power meter with power factor calculation

When operating the evaluation board, certain precautions need to be followed.

1. The power stage of the evaluation board has exposed high voltage and demands extra caution when operating. The voltage rating of the probes should meet the highest voltage present in the board. Isolation of the oscilloscope power source is needed when doing the measurement.
2. Power source considerations: It is important to choose the correct connector when attaching the source supply. An appropriate AC power supply is needed with adjustable output voltage (up to 300V) and current (up to 0.5A) with current limit capability.
3. Loading considerations: It is important to have a firm connection when attaching the load. In case an electronic load is used instead of the LED board, an appropriate electronic load with current up to 500mA and voltage up to 80V is desirable.
4. Air flow conditions: Full rated power should never be attempted without providing the specified 200 CFM of airflow over the LED board. This can be provided by a stand-alone fan.
5. When applying power the first time, it is suggested to apply light load, and set the current limit of the source supply to less than 1.5x of the wattage of the load. Start the circuit with the minimum AC voltage (80V). A quick efficiency check is the best way to confirm proper operation.
6. To measure the output voltage ripple more accurately, it is suggested to measure as closely as possible to the converter's output terminals. Since the AC signal being measured is small relative to the DC level, care must be exercised to minimize noise pick-up from external sources. The bandwidth of the oscilloscope can be set to 20MHz. Use very short and direct connections to the oscilloscope probe such that the total loop area in the signal and ground connections is as small as possible.

Figure 10 is the drain-source voltage of the switch. In Figure 11, the D-S voltages of the MOSFET are shown with the corresponding gate signal at input peak and valley, respectively. Three distinct modes of operation can be observed.

1. As the FET is on,  $V_{DS}$  is zero. The input voltage is applied to the inductor  $L_1$ , and the same voltage is applied to  $L_2$ . During this interval, the output load is powered by the output capacitor.
2. When the FET gate signal is removed, the current in inductor  $L_1$  begins to charge the capacitor  $C_2$  and the output capacitor  $C_O$  through the output diode. At the same time, the inductor  $L_2$  also charges the output capacitor. Power transfers from input to output.
3. Oscillation begins as this period is ended indicating DCM operation.

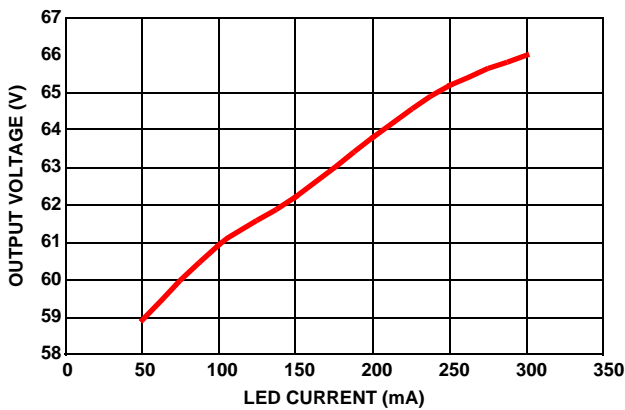

FIGURE 13. OUTPUT VOLTAGE vs CURRENT

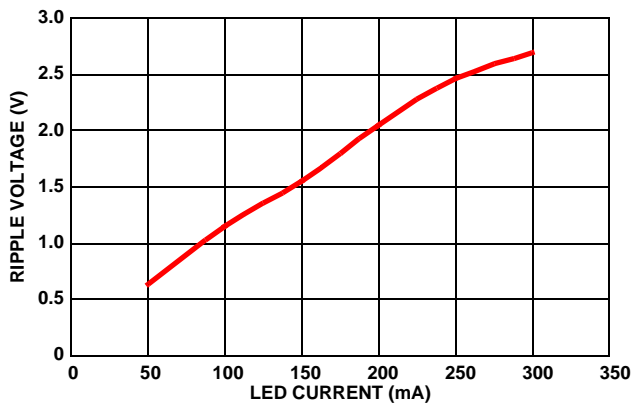

FIGURE 14. OUTPUT VOLTAGE RIPPLE (P-P)

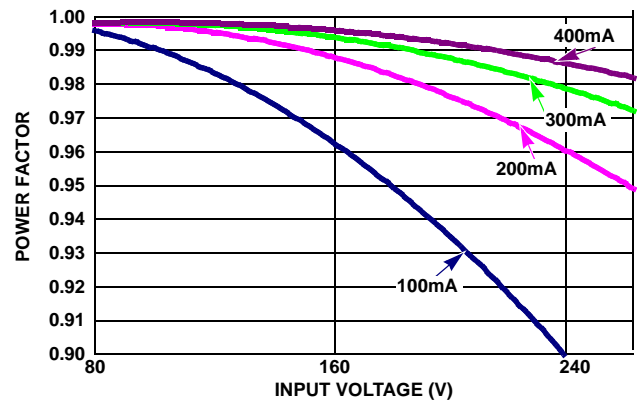

FIGURE 15. INPUT POWER FACTORS

Figures 4, 5 and 6 show the input current and the voltage across the input capacitor  $C_1$  for low line and high line operations. As can be seen from these waveforms, the power factor is comparatively high. Several possibilities can deteriorate the performance of the regulator:

1.  $L_1$  and  $L_2$  do not meet the design constraints causing the converter to operate in continuous conduction mode (CCM). Therefore, the energy stored in the inductors will be released to the DC capacitor  $C_1$ , which will cause input current waveform distortion.
2. The control bandwidth exceeds.
3. The current sense signal reaches the peak current protection threshold. This may be caused by the saturation of the inductor, or improper setting of the current sense resistor, or OCP limit.
4. Improper choice of the output capacitor.
5. The intermediate capacitor  $C_2$  is too big so that the voltage across it does not track the input voltage. The input current can be more distorted for high line operation since the capacitor  $C_2$  can only be optimized for one input voltage.
6. The inductors get saturated. In this case, the peak current limit will be exceeded and the current waveform will contain large amount of third order harmonics.

The output voltage and LED current are shown in Figures 7, 8 and 9 for various load conditions. The voltage across the LED strings (of 21 LEDs in series) is shown in Figure 13. The output voltage increases almost linearly with the LED current as expected. The ripple of the output voltage is governed by Equation 16 and is in proportion to the output power. The relation of the ripple to the load current is shown in Figure 14. The power factor versus input voltage for different LED currents is shown in Figure 15. For most of the operational conditions, the power factor is above 0.9.

**CAUTION:** This evaluation unit should be used and operated only by persons experienced and knowledgeable in the design and operation of high voltage power conversion equipment. Use of this evaluation unit constitutes acceptance of all risk inherent in the operation of equipment having accessible hazardous voltage. Careless operation may result in serious injury or death. Use safety classes of other suitable eye protection. The maximum voltage of ISL6745LEVAL2Z is 140V.

## Application Note 1411

### Bill of Materials for ISL6745UEVAL2Z

MANUFACTURER	PART NUMBER	QTY	REF DES	VALUE	VOLTAGE	TOL	PACKAGE
Panasonic	ECQU2A224ML	2	C1, C14	0.1μF	250VAC		T-H
Murata	GRM31BR72J472KW01L	3	C2	4.7nF	630VAC		1206
	Placeholder		C17, C18				
Murata	GRM43QR72J683KW01L	1	C3	68nF	630V		1812
Nippon Chem		1	C4	330μF	100V		T-H
TDK	C3216COG2J221J	1	C5	220pF	630V		1206
Murata		1	C6	2.2μF	25V	10%	0603
Murata		1	C7	2.2μF	25V	10%	0805
Murata	GRM188R71H221KA01D	2	C8, C13	220pF	50V	10%	0603
Murata	GRM32ER61C476ME15L	1	C10	47μF	16V	10%	1210
Murata	GRM188R71H331KA01D	3	C9, C11, C12	330pF	50V	10%	0603
Murata	GRM31CR72A105KA01L	1	C15	1.0μF	100V	10%	1206
Murata	GRM188R71H221KA01D	1	C16	220pF	50V	10%	0603
Murata	GRM188R71H221KA01D	1	C19	220pF	50V	10%	603
Diodes, Inc	1N4007	1	BR1-BR4	2A	1000V		T-H
Diodes, Inc	BYG24J	2	CR2, CR4	2A	600V		SMB
OnSemi	MMSD4148	1	CR3	0.2A	100V		SOD123
Littelfuse	396-1200xxxx	1	F1	2A			T-H
	Connector, DNP	1	J1				
CoilCraft	MSD1278-824KLB	1	L1	820μH	1.9A		SMT
CoilCraft	MSD1278-823KLB	1	L2	82μH	1.0A		SMT
CoilCraft	MSS1278-334KLB	1	L4	330μH	1A		SMT
	Test points		P1 to P4, P5 to P7				TP-150C100P
Infineon	SPD03N60C3	1	Q1	3.2A	650V		D-PAK
OnSemi	MJD50	1	Q2	1A	500V		D-PAK
Diodes, Inc	BSS138	1	Q3	200mA	50V		SOT-23
		2	R1, R2	1M		1%	1206
		2	R3, R4	2.55k		1%	2512
		2	R5, R6	49.9k		1%	1206
		1	R7	30.1k		1%	0603
		1	R8	10k		1%	0603
		1	R9	100k		1%	0603
		1	R10	1.43k		1%	0603
		1	R11	10k		1%	0603
		1	R12	34.0k		1%	0603
		1	R13	10.0		1%	1206
		1	R14	100mΩ		1%	2512
		2	R15, R16	100		1%	2512
		1	R17	7.15		1%	2512



## Application Note 1411

### Bill of Materials for ISL6745UEVAL2Z (Continued)

MANUFACTURER	PART NUMBER	QTY	REF DES	VALUE	VOLTAGE	TOL	PACKAGE
		1	R18	10.0k		1%	0603
	DNP	1	R19	POT31			T-H
		1	R20	1k		1%	603
		1	R21	10/1W			2512
		1	R22	909k		1%	603
	Test point, DNP		TP1 to TP4				pad-70c43p
Intersil	ISL6745AUZ	1	U1				MSOP-10
Intersil	EL5220	1	U2				SO-8
Diodes, Inc	AP432-SR	1	U3				SOT-23R
Philips	BZX84-C11	1	VR1		11V	5%	SOT-23
Littelfuse	TMOV14R260E	1	Z1		250VAC		T-H

### Bill of Materials for ISL6745LEVAL2Z

MANUFACTURER	PART NUMBER	QTY	REFERENCE DESIGNATOR	DESCRIPTION
TBD	ISL6745EVAL2ZREVAPCB	1	SEE LABEL-RENAME BOARD	PWB-PCB, ISL6745EVAL2Z, REVA, ROHS
TDK	C3216C0G2J221J-T	1	C5	CAP, SMD, 1206, 220pF, 630V, 5%, COG, ROHS
PANASONIC	ECQ-U2A224ML	2	C1, C14 (C1-Install on back of board)	CAP, RADIAL, 17.5x16, 0.22µF, 250/275V, 20%, POLY FILM, ROHS
MURATA	GRM31BR72J472KW01L	1	C2	CAP, SMD, 1206, 4700pF, 630V, 10%, X7R, ROHS
MURATA	GRM43QR72J683KW01L	1	C3	CAP, SMD, 1812, 0.068µF, 630V, 10%, X7R, ROHS
MURATA	H1045-00221-50V10-T	3	C8, C13, C16	CAP, SMD, 0603, 220pF, 50V, 10%, X7R, ROHS
MURATA	H1045-00225-16V10-T	1	C6	CAP, SMD, 0603, 2.2µF, 16V, 10%, X5R, ROHS
YAGEO	H1045-00331-50V10-T	3	C9, C11, C12	CAP, SMD, 0603, 330pF, 50V, 10%, X7R, ROHS
	H1045-DNP	0	C19	CAP, SMD, 0603, DNP-PLACE HOLDER, ROHS
PANASONIC	H1046-00225-25V10-T	1	C7	CAP, SMD, 0805, 2.2µF, 25V, 10%, X5R, ROHS
VENKEL	H1065-00105-100V10-T	1	C15	CAP, SMD, 1206, 1µF, 100V, 10%, X7R, ROHS
TDK	H1082-00476-16V20-T	1	C10 (Use on 1206 pad layout)	CAP, SMD, 1210, 47µF, 16V, 20%, X5R, ROHS
NICHICON	UVZ2A102MHD	1	C4	CAP, RADIAL, 5x11, 1000µF, 100V, 20%, ALUM.ELEC., ROHS
COILCRAFT	MSD1278-393MLB	1	L2	COIL-COUPLED INDUCT, SMD, 12.3mm, 39µH, 20%, 5.5A, ROHS
COILCRAFT	MSD1278-394KLB	1	L1	COIL-COUPLED INDUCT, SMD, 12.3mm, 390µH, 10%, 1.7A, ROHS
COILCRAFT	MSS1278-334KLB	1	L4	COIL-PWR INDUCTOR, SMD, 12.3mm, 330µH, 10%, 2A, ROHS
KEYSTONE	1514-2	4	P1, P2, P8, P9	CONN-TURRET, TERMINAL POST, TH, ROHS
DIODES INC.	1N4007	4	BR1-BR4	DIODE-RECTIFIER, AXIAL, DO-41, 1000V, 1A, ROHS
VISHAY	BYG24J/TR3	2	CR2, CR4	DIODE-RECTIFIER, SMD, 2P, SMA, 600V, 1.5A, ROHS

## Application Note 1411

### Bill of Materials for ISL6745LEVAL2Z (Continued)

MANUFACTURER	PART NUMBER	QTY	REFERENCE DESIGNATOR	DESCRIPTION
NXP SEMICONDUCTORS	BZX84-C11-T	1	VR1	DIODE-ZENER, SMD, SOT23,10.4V to 11.6V, 5%, 200mA, ROHS
FAIRCHILD	MMSD4148-T	1	CR3	DIODE-SWITCHING, SMD, 2P, SOD-123, 100V, 200mA, ROHS
INTERSIL	ISL6745AUZ	1	U1	IC-HIGH SPEED BRIDGE CONTROLLER, 10P, MSOP, ROHS
FAIRCHILD	LM358AM	1	U2	IC-DUAL OP AMP, 8P, SOIC, ROHS
TEXAS INSTRUMENTS	LM4041DIDBZR-T	1	U3	IC-ADJ.SHUNT VOLT.REF, SMD, 3P, SOT-23, 1.225V to 10V, 12mA, ROHS
ON SEMICONDUCTOR	BSS138LT1G-T	1	Q3	TRANSIST-MOS,N-CHANNEL, SMD, 3P, SOT23, 50V, 200mA, ROHS
ON SEMICONDUCTOR	MJD47T4G-T	1	Q2	TRANSISTOR, NPN, SMD, 3P, D-PAK, 50V, 1A, BIPOLAR, ROHS
INFINEON TECHNOLOGY	SPD03N60C3T	1	Q1	TRANSISTOR-MOS, N-CHANNEL, SMD, D2-PAK, 650V, 3.2A, ROHS
KOA	H2511-01000-1/10W1-T	1	R16	RES, SMD, 0603, 100Ω, 1/10W, 1%, TF, ROHS
KOA	H2511-01001-1/10W1-T	1	R20	RES,SMD,0603, 1k, 1/10W, 1%, TF, ROHS
KOA	H2511-01002-1/10W1-T	3	R8,R11,R18	RES,SMD, 0603, 10k, 1/10W, 1%, TF,ROHS
	H2511-01003-1/10W1-T	1	R9	RES,SMD, 0603, 100k, 1/10W, 1%, TF, ROHS
PANASONIC	H2511-01431-1/10W1-T	1	R10	RES, SMD, 0603, 1.43k, 1/10W, 1%, TF, ROHS
VENKEL	H2511-03012-1/10W1-T	1	R7	RESISTOR, SMD, 0603, 30.1k, 1/10W, 1%, TF, ROHS
VENKEL	H2511-03402-1/10W1-T	1	R12	RES, SMD, 0603, 34k, 1/10W, 1%, TF, ROHS
VENKEL	H2511-09093-1/10W1-T	1	R22	RES, SMD, 0603, 909k, 1/10W, 1%, TF, ROHS
VENKEL	H2513-00100-1/4W1-T	1	R13	RES, SMD,1206, 10Ω, 1/4W, 1%, TF, ROHS
VENKEL	H2513-01004-1/4W1-T	2	R1,R2	RES, SMD,1206, 1M, 1/4W, 1%, TF, ROHS
VENKEL	H2513-04992-1/4W1-T	2	R5,R6	RES, SMD, 1206, 49.9k, 1/4W, 1%, TF, ROHS
VISHAY	H2515-00100-1W1-T	1	R21	RES, SMD, 2512, 10Ω, 1W, 1%, TF, ROHS
DALE	H2515-00R10-1W1-T	1	R14	RES, SMD, 2512, 0.1Ω, 1W, 1%, TF, ROHS
VENKEL	H2515-01000-1W1-T	1	R15	RES, SMD, 2512, 100Ω, 1W, 1%, TF, ROHS
VENKEL	H2515-02551-1W1-T	2	R3,R4	RES, SMD, 2512, 2.55k, 1W, 1%, TF, ROHS
VENKEL	H2515-07R15-1W1-T	1	R17	RES, SMD, 2512, 7.15Ω, 1W, 1%, TF, ROHS
	BUSSWIRE-18AWG	1	F1 (Solder wire to pads to create short)	WIRE, 18AWG, SOLID, BUS COPPER JUMPER
3M	SJ-5003-BLACK	4	Bottom four corners.	BUMPONS, 0.44inW x 0.20inH, DOMETOP, BLACK
INTERSIL COMMON STOCK	8x12-STATIC-BAG	1	Place assy in bag.	BAG, STATIC, 8x12, ZIP LOC
	DNP	0	C17,C18	DO NOT POPULATE OR PURCHASE
	DNP	0	J1	DO NOT POPULATE OR PURCHASE
	DNP	0	P5,P6,P7	DO NOT POPULATE OR PURCHASE
	DNP	0	R19	DO NOT POPULATE OR PURCHASE
	DNP	0	TP1-TP4	DO NOT POPULATE OR PURCHASE

## Application Note 1411

### Bill of Materials for ISL6745LEVAL2Z (Continued)

MANUFACTURER	PART NUMBER	QTY	REFERENCE DESIGNATOR	DESCRIPTION
	LABEL-RENAME BOARD	1	RENAME PCB TO: ISL6745LEVAL2Z.	LABEL, TO RENAME BRD
	LABEL-SERIAL NUMBER	1		LABEL, FOR SERIAL NUMBER AND BOM REV #
LITTLEFUSE INC	TMOV14RP140E	1	Z1 (Install on back of board)	VARISTOR-MOV,RADIAL,DISK,140V,6000A,ROHS

# ISL6245UEVAL2Z Schematic

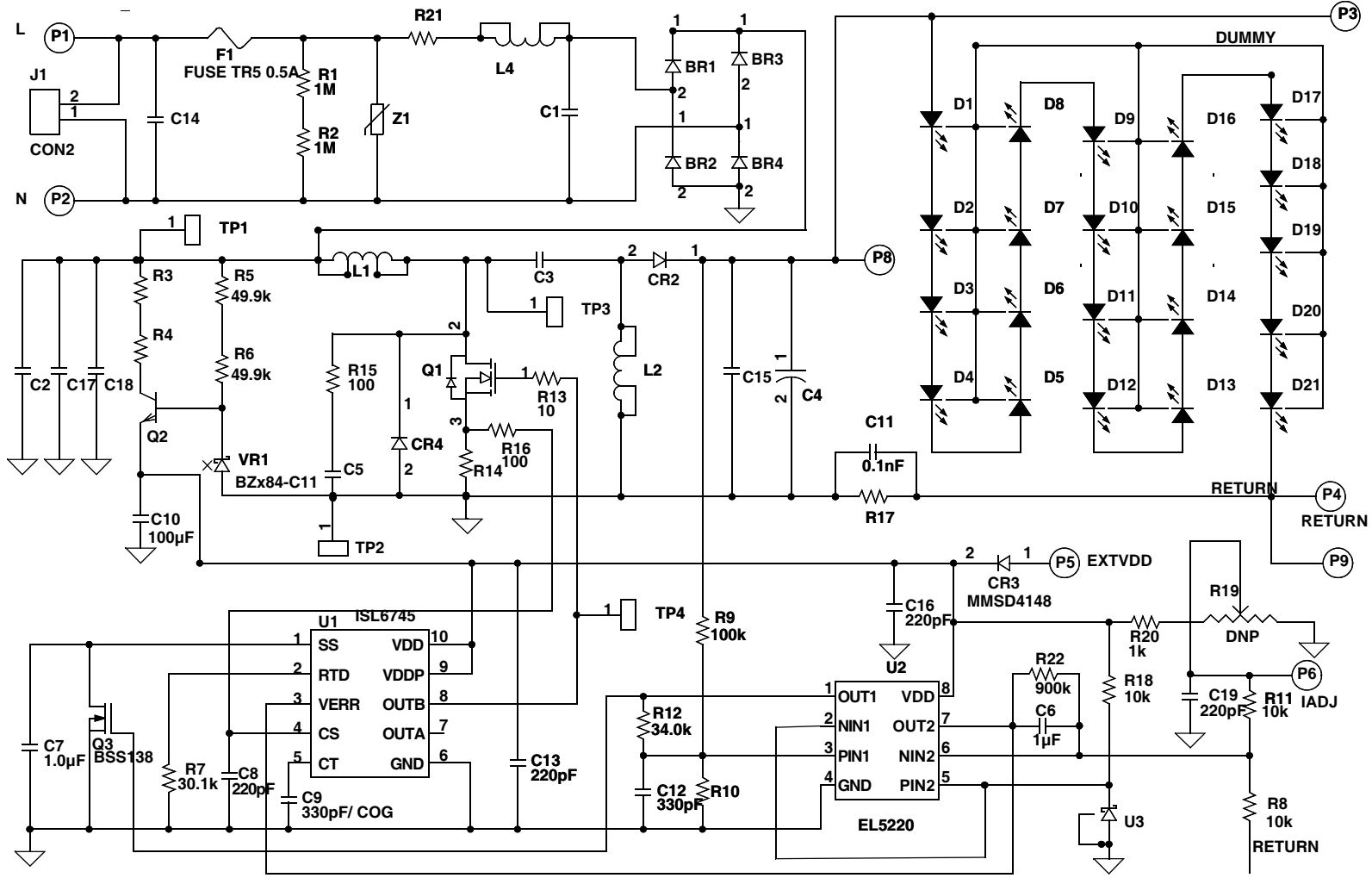

- NOTES:**  
 Unless otherwise specified  
 1) All Capacitors are Ceramic 10%  
 2) All Resistors are 1%

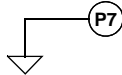

ISL6745EVAL2Z Layout

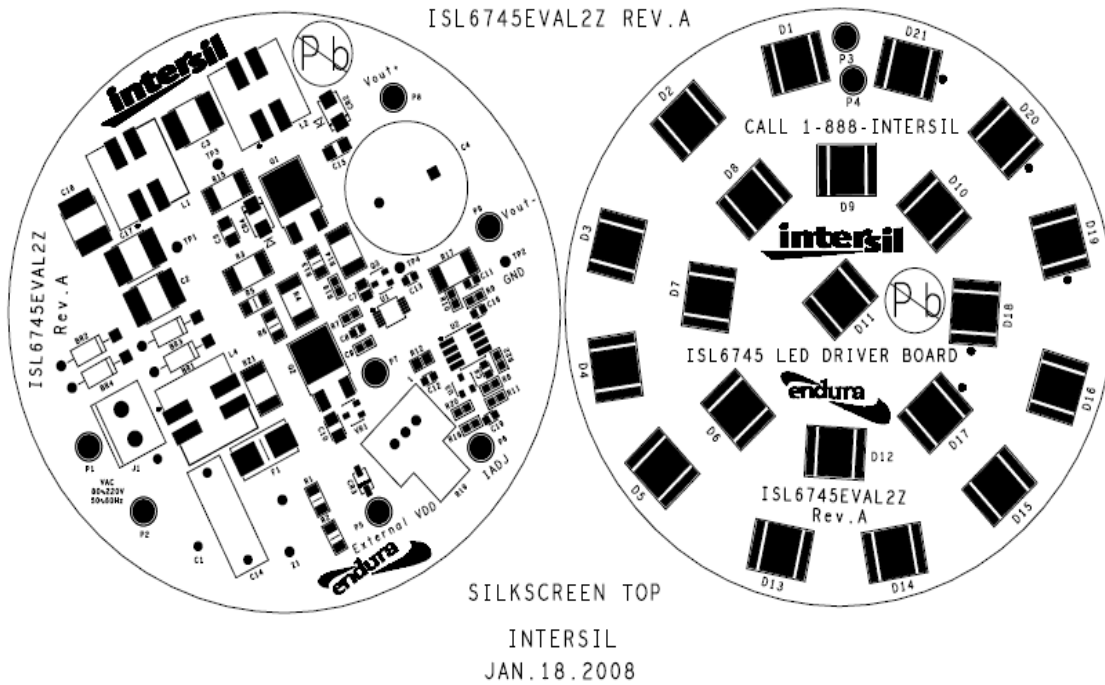

FIGURE 16. TOP SILKSCREEN

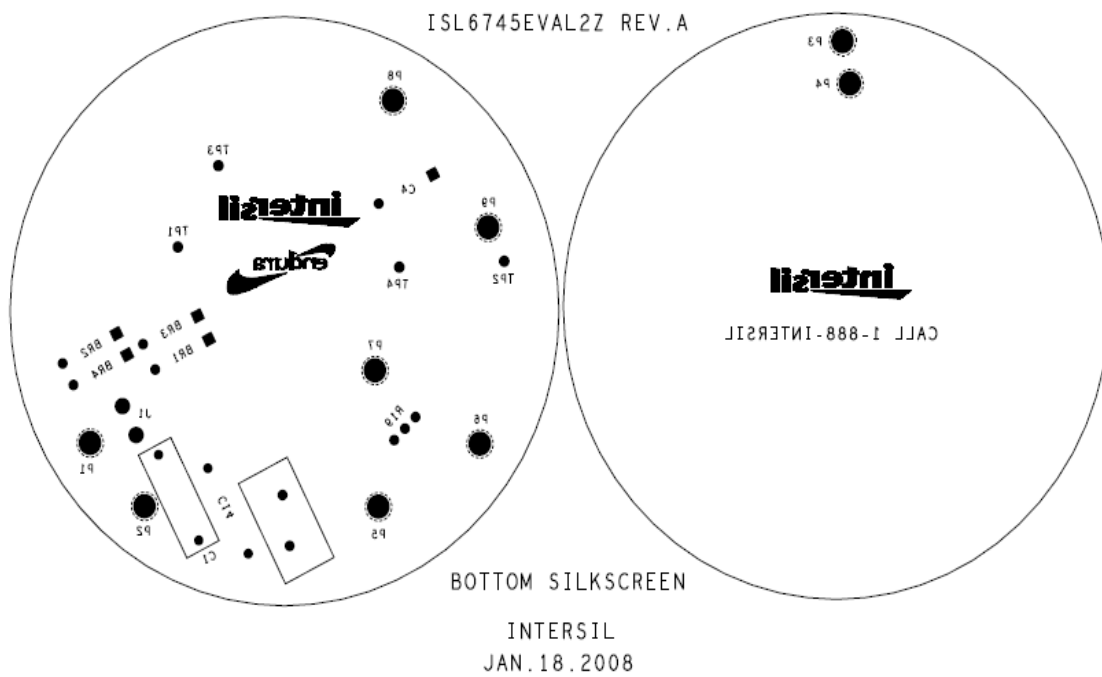

FIGURE 17. BOTTOM SILKSCREEN

### References

1. [http://www.iaeel.org/iaeel/news/1993/ett1993/polup\\_1\\_93.html](http://www.iaeel.org/iaeel/news/1993/ett1993/polup_1_93.html)
2. Robert U. Ayresa, Leslie W. Ayresa and Vladimir Pokrovskyd, On the efficiency of US electricity usage since 1900, Energy, Volume 30, Issue 7, June 2005, pp 1092-1145.
3. [http://www.energystar.gov/index.cfm?c=cfls.pr\\_cfls](http://www.energystar.gov/index.cfm?c=cfls.pr_cfls)
4. Zheludev, N. (2007). The life and times of the LED, a 100-year history. Nature Photonics 1 (4): pp 189–192.
5. [www.cree.com](http://www.cree.com)
6. F. Greenfeld, White LED driver circuits for off-Line applications using standard PWM controllers, Intersil Application Note.
7. Z. Ye, F. Greenfeld, G. Liang, Design considerations of a high power factor SEPIC converter for high brightness white LED lighting applications,” IEEE PESC conference record, 2008, June 2008, Greece, pp 2657-2663.
8. Dixon, High power factor pre-regulator using the SEPIC converter, Unitrode Seminar SEM900, Topic 6, 1993.
9. Min Chen, Anu Mathew, and Jian Sun, Nonlinear Current Control of Single-Phase PFC Converters, IEEE Trans on Power Electronics, Vol. 22, No. 6, NOV. 2007 pp 2187-2194
10. [G. Spiazzi and P. Mattavelli, Design criteria for power factor pre-regulators based on SEPIC and Cuk converters in continuous conduction mode, Proceedings of IEEE-IAS Annual Meeting, 1994, pp. 1084–1089.

---

*Intersil Corporation reserves the right to make changes in circuit design, software and/or specifications at any time without notice. Accordingly, the reader is cautioned to verify that the Application Note or Technical Brief is current before proceeding.*

---

For information regarding Intersil Corporation and its products, see [www.intersil.com](http://www.intersil.com)