

Test Procedure for the LV5012MD2GEVB Evaluation Board

1. Test Setup

1.1 Test Equipment

Voltage Source: 120VAC AC source, NF EPO2000S

Power Meter: HIOKI 3332

Volt Meter: ADVANTEST R6441D DIGITAL MULTIMETER

AMP Meter: Agilent DIGITAL MULTIMETER 34401A

Output Load: 2 Parallel of 6 LEDs series (LED: CREE XLamp MX-3S LEDs)

Oscilloscope: LeCroy WaveRunner 6050A

Operating Temperature: 25°C

1.2 Recommended Test Setup

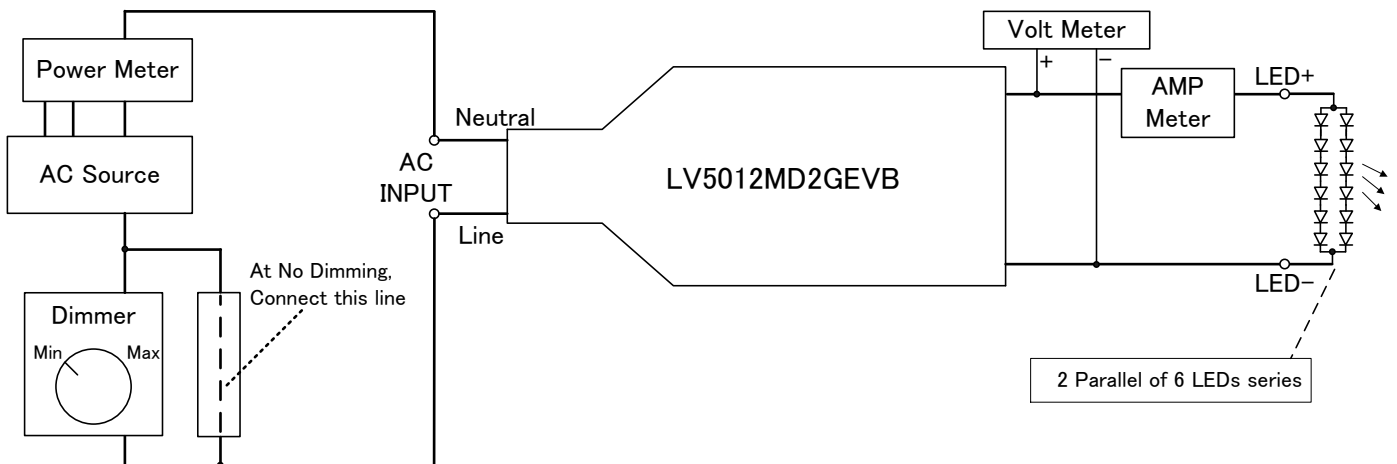

Figure1. LV5012MD2GEVB Recommended Test Set Up

1.3 List of Test Points

Table1. Test Points Functions

TEST POINTS NAME	DESCRIPTION
Neutral	120VAC neutral connection
Line	120VAC line voltage
LED+	LED anode connection
LED-	LED cathode connection



2. Test Procedure

2.1 Line/Load Regulation and Efficiency Measurement Procedure

1. Connect LV5012MD2GEVB like upper Figure1. An external LED load must be used to start up the EVB.
2. Prior to turning on the AC source, set the voltage to 120V_{AC}.
3. Turn on the AC Source.
4. Record the output voltage readings from Volt Meter and the output current reading from AMP Meter. And Record the input power reading from Power Meter.
5. Change VAC from 108VAC to 132VAC and perform "4".
6. Refer to Section 2.2 for shutdown procedure.

2.2 Equipment Shutdown

1. Turn off equipment.
2. Make sure capacitors are discharged.

2.3 Phase Angle Decode vs LED Current (at dimming)

1. Connect LV5012MD2GEVB like upper Figure1. An external LED load must be used to start up the EVB.
2. Prior to turning on the AC source, set the voltage to 120V_{AC}.
3. Monitor the Dimmer output AC voltage between the neutral and the line by using the oscilloscope differential probe.
4. Turn on the AC Source.
5. Maximize the dimmer ratio.
6. Record the output voltage readings from Volt Meter and the output current reading from AMP Meter. And Record the input power reading from Power Meter. And Record the phase angle of Dimmer output reading from the oscilloscope differential probe.
7. Gradually lower the Dimming ratio and perform "6". Repeat it until the Dimming ratio is minimized.
8. Refer to Section 2.2 for shutdown procedure.

3. Performance Data

3.1 Efficiency

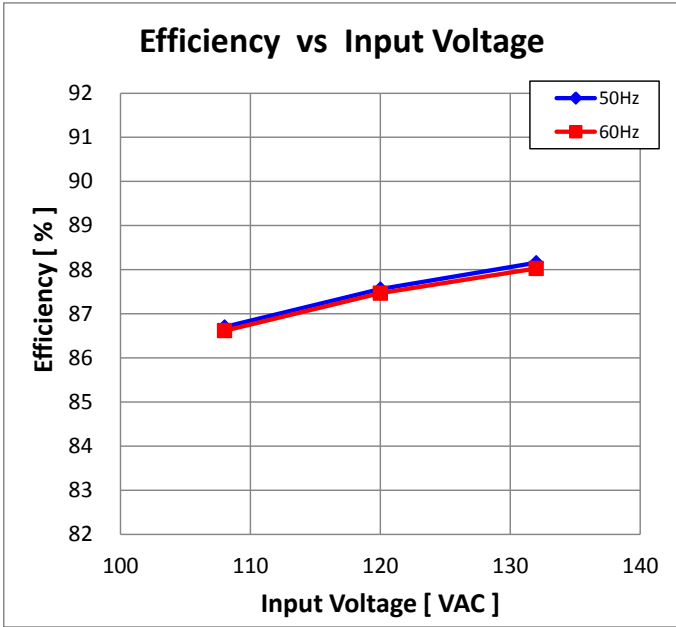

Figure2. Efficiency vs Input voltage

3.2 Power factor

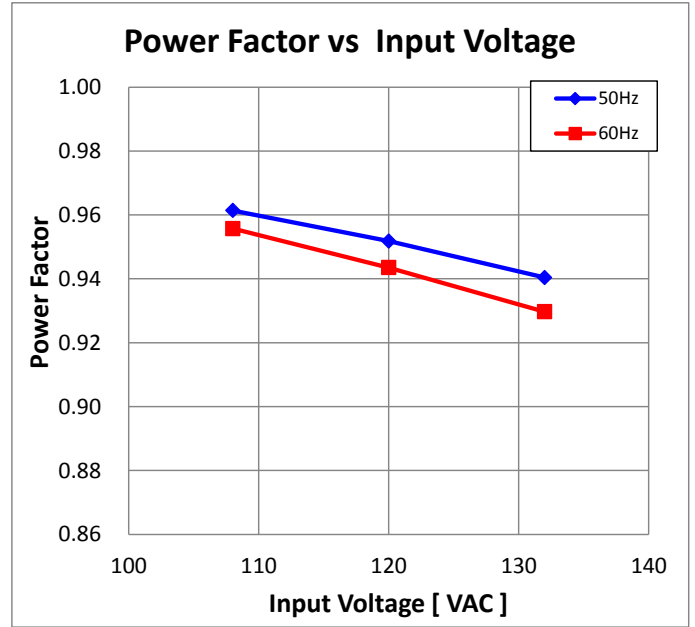

Figure3. Power factor vs Input voltage

3.3 LED Current (Output current)

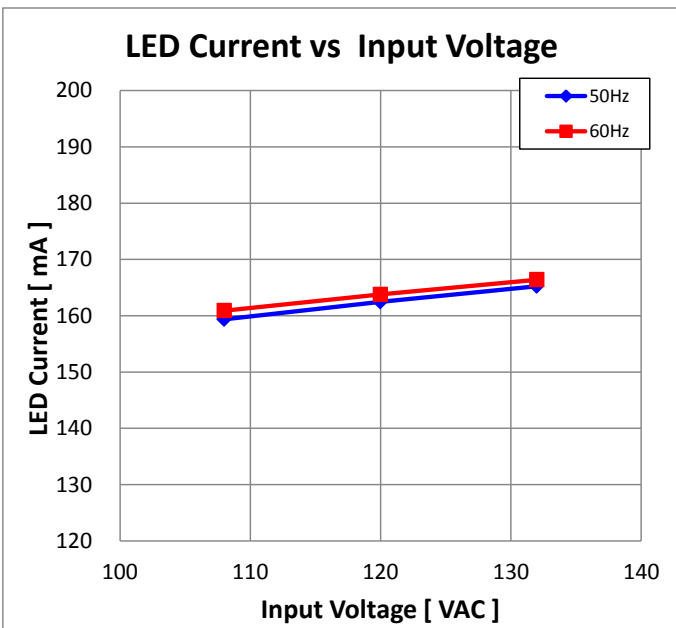

Figure4. LED current vs Input voltage

3.4 Output Voltage

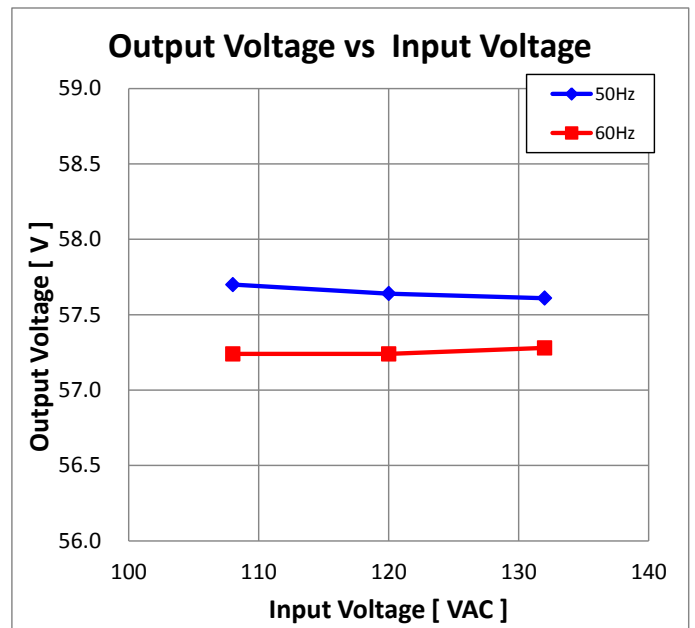

Figure5. Output voltage vs Input voltage

3.5 Input voltage/current operation waveform (No dimming)

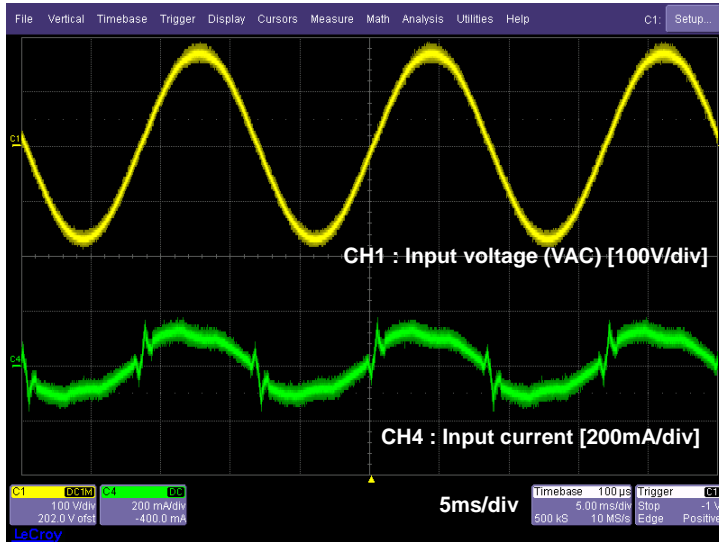

Figure6. Input waveform

3.6 Output voltage/current operation waveform (No dimming)

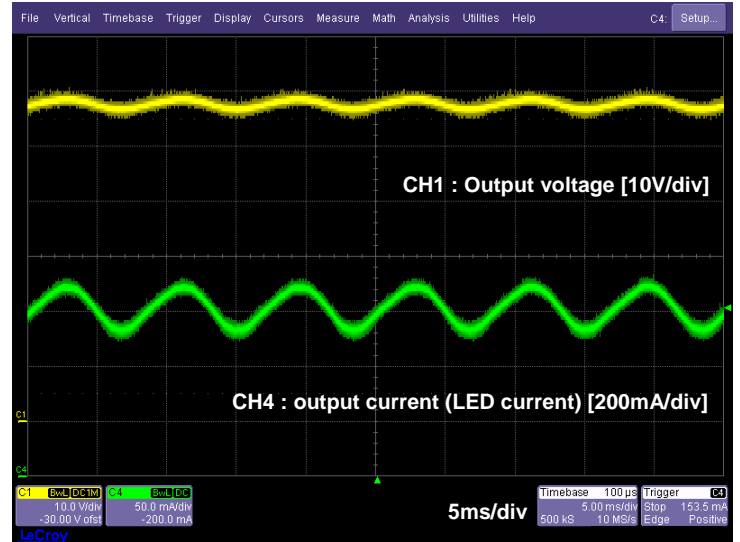

Figure7. Output waveform

3.7 Switching operation waveform

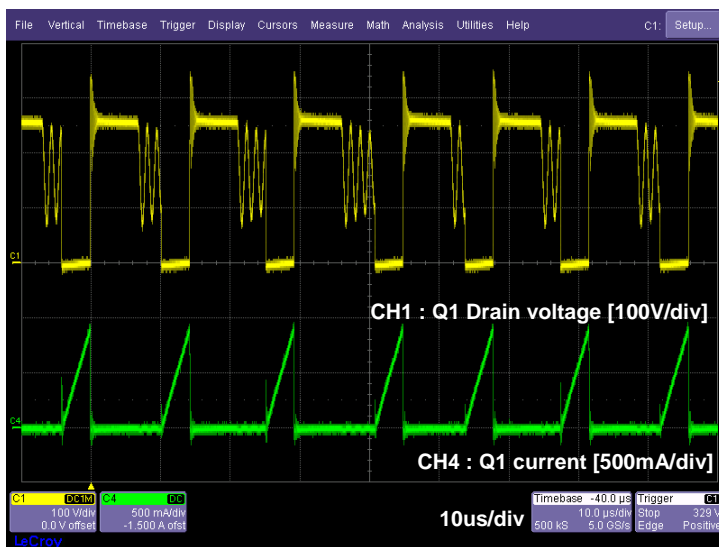

Figure8. Switching operation waveform

3.8 LED Current vs Phase angle

[VAC=120V, 60Hz, Dimmer : LEVITON IPI06]

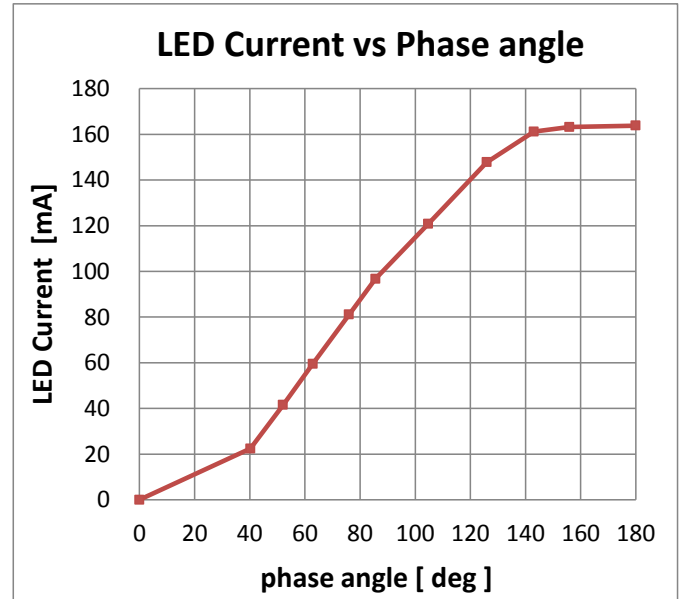

Figure9. LED current vs Phase angle

3.9 Dimming operation waveform

Phase angle = 120 degree

[VAC=120V, 60Hz, Dimmer : LEVITON IPI06]

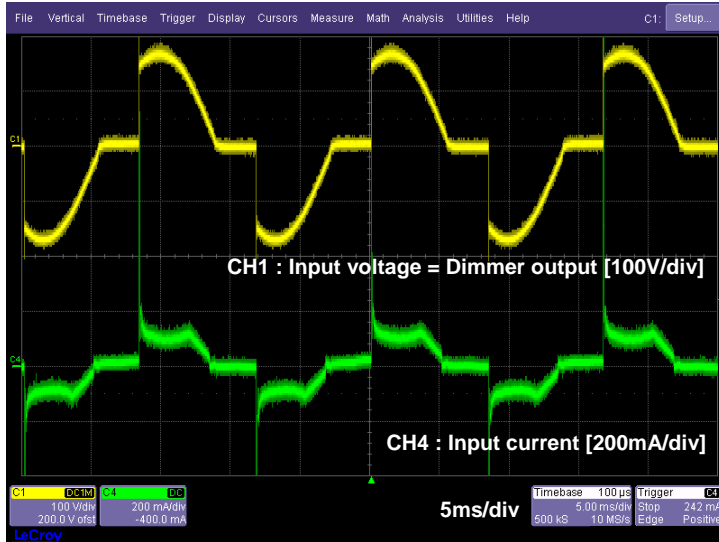

Figure10. Dimming operation waveform at phase angle=120degree

3.10 Dimming operation waveform

Phase angle = 60 degree

[VAC=120V, 60Hz, Dimmer : LEVITON IPI06]

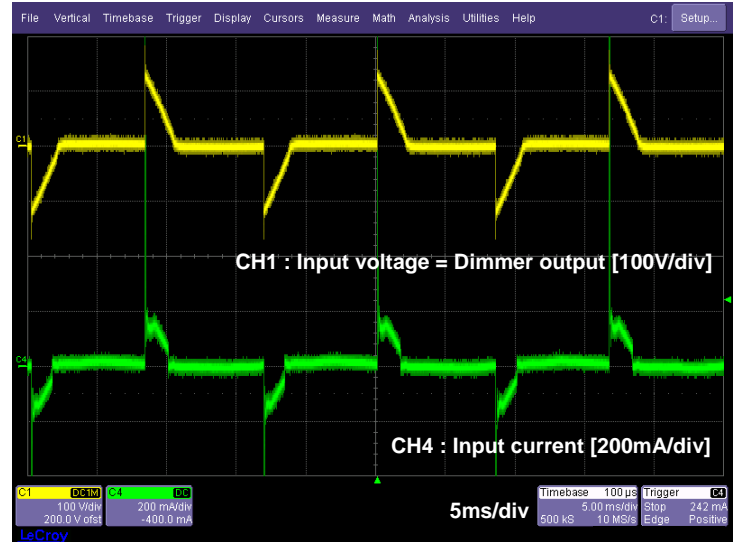

Figure11. Dimming operation waveform at phase angle=60degree